



HALDANE

Contour Catalogue



HALDANE

ABOUT

Contour

Distinguished by its' graceful circular geometries, restrained palette + oversized volumes, the Contour Daybed reconnects us with the natural world. Inspired by organic shapes and body positivity, this escapist future-icon from Haldane is an expression of the brand's ethos of integrating culture and nature.

HALDANE



COLLECTIONS

Contour

Daybed + Canopy

ASSEMBLED SIZE (MM) L2000 X W2000 X H2060

ESTIMATED WEIGHT (KG) 390KG

MATERIALS CANOPY SCREENTEX

MATERIALS FRAME MARINE GRADE SS316

MATERIALS UPHOLSTERY CREVIN FIJI (IMP)

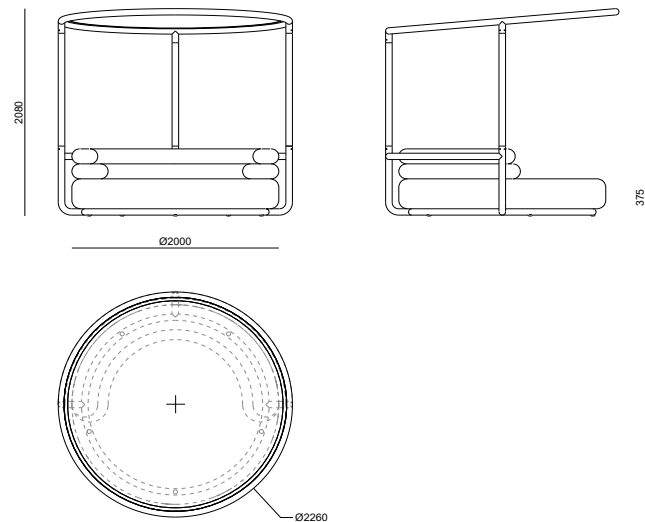

HALDANE



COLLECTIONS

Contour Daybed

ASSEMBLED SIZE (MM) L2000 X W2000 X H2060

ESTIMATED WEIGHT (KG) 350KG

MATERIALS FRAME MARINE GRADE SS316

MATERIALS UPHOLSTERY CREVIN FIJI (IMP)

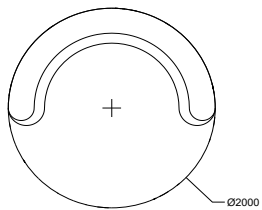

HALDANE



FINISHES

Upholstery

Crevin Fiji (IMP)

Fiji (IMP) is a textured jacquard weave option for fully outdoor conditions as this beautiful and functional upholstery fabric collection can be spot cleaned allowing the easy removal of mildew. Crevin's Fiji (IMP) fabrics are finished with stain-repellence and with an internal layer of waterproof lamination.

CARE + MAINTENANCE

Care for your upholstery by regularly brushing off loose dirt with a soft brush. When dirty, spot clean using a soft bristle brush to scrub on a solution of water and mild soap. Allow the cleaning solution to soak into the fabric. Rinse thoroughly until all soap residue is removed and then air dry. Make use of weather covers when furniture is on uncovered patios.



Crevin - Fiji IMP 07 - Snow



Crevin - Fiji IMP 51 - Granite

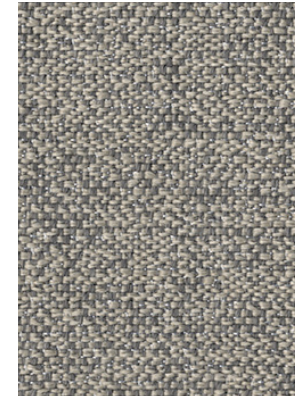

Crevin - Fiji IMP 75 - Avalanche

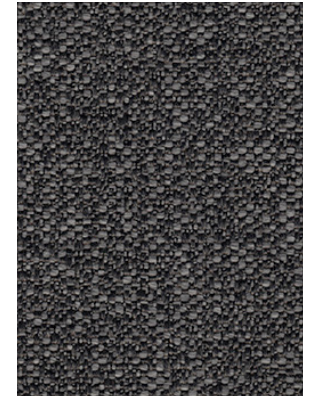

Crevin - Fiji IMP 83 - Graphite

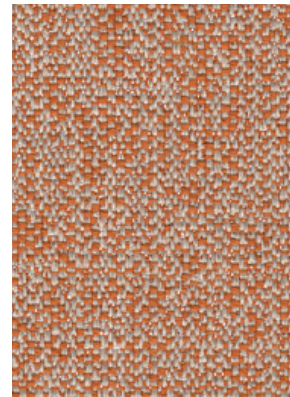

Crevin - Fiji IMP 29 - Citrus



Crevin - Fiji IMP 32 - Palm

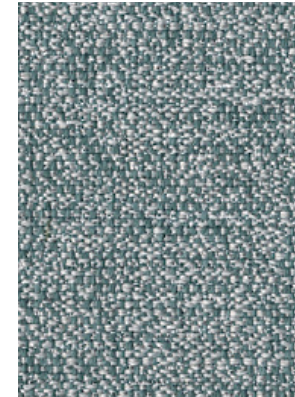

Crevin - Fiji IMP 43 - Seaside



Crevin - Fiji IMP 47 - Midnight

FINISHES

Frame Powder Coat

The Contour Day bed frame is made in Marine Grade stainless steel SS316. They are powder coated in exterior grade UV stable pure polyester with a luxurious ferro grain finish in the colour of your choice from our extensive colour palette.

CARE + MAINTENANCE

Care for your powder coated stainless steel by wiping when dirty or weekly with a damp cloth soaked in a solution of mild detergent (like Sunlight Liquid) and water. Avoid harsh chemical cleaning products and scratching with sharp objects as this can damage the powder coating.



Traffic White



Silk Grey



Light Grey



Basalt Grey



Umber Grey



Jet Black



Cream



Beige Red



Coral Red



Purple Red



Chestnut Brown



Ochre Brown

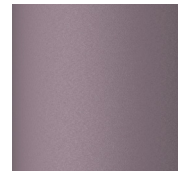

Pastel Violet



Pale Green



Emerald Green

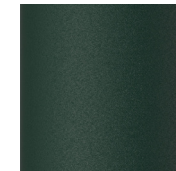

Moss Green



Olive Green



Lemon Yellow



Pastel Turquoise



Gentian Blue



Night Blue



Ocean Blue



HALDANE

Care + Maintenance

1. OUTDOOR STEEL POWDER COATING CARE

Care for your powder coated stainless steel & aluminium components by wiping when dirty with a damp cloth soaked in a solution of mild detergent (like Sunlight Liquid) and water. For coastal environments (within 200m of the ocean) it is necessary to make use of Marine Grade stainless steel SS316 and to wipe sea air condensation off of your furniture on a weekly basis. Avoid harsh chemical cleaning products and scratching with sharp objects as this can damage the powder coating.

2. OUTDOOR UPHOLSTERY FABRIC CARE

Care for your upholstery by regularly brushing off loose dirt with a soft brush. When dirty, spot clean using a soft bristle brush to scrub on a solution of water and mild soap. Allow the cleaning solution to soak into the fabric. Rinse thoroughly until all soap residue is removed and then air dry. Make use of weather covers when furniture is on uncovered patios or take removable upholstery indoors.

3. IROKO TIMBER CARE

For general cleaning, use a clean cloth to wipe down timber components with a solution of Rubio® Monocoat Exterior Soap and water. Allow the surface to dry.

For MAINTENANCE reapply Rubio® Monocoat Hybrid Wood protector every 6 to 12 months, depending on the level of exposure to the outdoor elements.

Clean as above with Rubio® Monocoat Exterior Soap. Rinse thoroughly until all the foam has disappeared.

Allow the surface to dry well (± 30 minutes at a temperature of 20 °C and proper ventilation).

Treat with the Rubio® Monocoat Hybrid Wood Protector in the same colour as your original application.

Apply the oil with a clean cloth. Allow a few minutes for the product to react. Remove any excess oil.

WARNING Cloths, saturated with oil, may spontaneously combust. Soak cloths in water after use before disposal.

4. DEKTON TABLE TOP CARE

Due to its practically zero porosity, the ultra-compact Dekton® surface is highly resistant to staining in day-to-day use and from chemical products, making it ideal for use as a table top for both inside and out.

For general cleaning, Cosentino recommends the use of Q-Action with a sponge or soft cloth. If this product is not available, the best option is to use a neutral soap (like Sunlight liquid) and water.

WARNING Do not mechanically polish the surface. Avoid using metal scouring pads. Whilst the table top material is incredibly durable, they can break when hit with heavy objects.

Limited Warranty

HALDANE MARTIN DESIGN (PTY) LTD (Seller) offers a limited warranty on products sold by the Seller to the purchaser (Purchaser), covering defects in material and workmanship for a period of 3 years from the date of invoice, subject to terms, conditions and limitations described below.

1. Products sold directly from the showroom floor, acquired on Sale, in customers' own materials and Prototypes are excluded from this Limited Warranty.
2. Only the customer who originally purchased a new product from the Seller or its' authorized dealers may make claims under the Limited Warranty. The Limited Warranty does not extend to any subsequent buyer or other transferee.
3. The Seller will repair or replace any product(s) determined by the Seller to be defective within the applicable Warranty Period. The seller has the right at its' sole discretion to grant a refund for the affected product and to inspect any product claimed defective before making a final determination of the claim.
4. SELLERS LIABILITY IS LIMITED to the repair or replacement of any product determined by the Seller to be defective in accordance with the terms of this warranty.
5. DISCLAIMER OF LOSS The Seller shall not be liable for lost profits, replacement rental costs, other costs of repair or replacement, or any consequential, special, indirect or incidental damages to anyone, anything or any place resulting from any defects in material or workmanship.
6. IMPROPER CARE AND USE Our furniture requires cleaning and maintenance as stipulated above. The Seller will not repair or replace the furniture that has been abused, neglected, exposed to extreme humidity (relative humidity over 90%), extreme temperature (below -5°C or above 40° C), alterations to the product or unauthorized repair. The Seller will also not cover damage that results from normal wear and tear from use or the general passing of time (for example scratches, burns, watermarks, indentations, pilling, fading or wrinkling of fabric).
7. DIFFERENCES IN COLOUR Minor variations of colour and grain of timber elements or fabric(s) might occur from piece to piece. These variations do not constitute a defect in material and/or workmanship under this Limited Warranty and minor differences between our furniture and illustrations or images are not covered by this Limited Warranty.



HALDANE

42 Roodebloem Road
Woodstock, Cape Town

www.haldane.co.za
info@haldane.co.za